

## COLECCIÓN TECHNIC BATIENTE

### GARANTÍA

COSMIC garantiza por un periodo de 5 años todos los defectos de materia prima y fabricación. Esta garantía consiste en la sustitución de la pieza que determine su irregular funcionamiento, salvo por razones de uso inadecuado, montaje o instalación incorrectos (si el producto no ha sido instalado por el Servicio Técnico Oficial), desgaste natural, mantenimiento indebido o defectos provocados por reacciones químicas, electroquímicas o eléctricas.

### DATOS TÉCNICOS

Las mamparas de baño/ducha **Cosmic** cumplen con los requisitos establecidos en la norma EN 14428 de obligado cumplimiento de acuerdo con la directiva europea 89/106/CEE.

#### 1 ASPECTOS RELATIVOS A LA MAMPARA

- **LIMPIEZA:** Los sistemas divisorios están libres de ángulos, aristas vivas, asperezas, bordes y rebabas para facilitar su acceso y su limpieza.
- **RESISTENCIA A LA CORROSIÓN:** Todos los componentes están constituidos por materiales resistentes a la corrosión. Tanto el recubrimiento de aluminio como la presentación de adherencia mínima cumplen las normas ISO 7599 y en ISO 2409 respectivamente.
- **RESISTENCIA A PRODUCTOS QUÍMICOS:** Las partes acristaladas son resistentes al uso de productos químicos. Su estética y color permanece inalterable al paso del tiempo.
- **RESISTENCIA A LOS CICLOS DE HUMEDAD:** Los sistemas divisorios se mantienen intactos a los cambios de humedad.
- **ENDURANCIA:** Los sistemas divisorios son sometidos a un test de 20.000 ciclos de apertura y cierre que garantiza su perfecta funcionalidad.
- **ESTABILIDAD:** El uso de vidrio templado en los sistemas divisorios asegura una mayor estabilidad, resistiendo a una energía que representa el impacto de un cuerpo humano sobre una amplia zona.
- **ESTANQUEIDAD:** Cada nuevo modelo se somete a estrictas pruebas que certifican su estanqueidad. Algunos modelos de puertas batientes pueden presentar pequeñas fugas de agua a través del sistema interior de bisagras.

## Principales características técnicas colección TECHNIC BATIENTE:

- Vidrio templado 6 MM.
- Compensación 15 MM. (excepto DBE1/DSE2/DPE2 compensación 25 MM)
- Altura modelo ducha 1950 MM.
- Apertura 180°.
- Reversible.
- Medidas y alturas especiales, consultar tarifa.
- Up & Down.
- Tratamiento DROP FREE opcional.
- Plegable (DPE2/DPL2)
- Apto para adaptar a personas con movilidad reducida (excepto DPE2/DPL2 i CS24/34)

## ASPECTOS RELATIVOS A LOS COMPONENTES DE LA MAMPARA

### 2.1.- Materiales y Acabados

| Tipología de pieza          | Materiales   | Propiedades/Requisitos  | Acabados   |
|-----------------------------|--|---|--|
| Perfiles                    | Aluminio (aleación 6063/T6 para acabado brillo)<br>Acero inoxidable AISI 304 |   | - Blanco<br>- Plata brillo<br>- Plata mate   |
| Burletes y magnéticos       | PVC doble dureza (parte rígida "shore" 80 y parte flexible "shore" 60)       | Aditivo resistencia rayos UVA   | Transparente   |
| Juntas                      | EPDM shore A 90±5  |   | Gris RAL 7047  |
| Tornillería                 | Acero inoxidable AISI 302  |   |  |
| Piezas metálicas            | ZAMAK 3<br>Acero inoxidable AISI 304   | Resistencia corrosión: 200h<br>NSST EN-248:2003                         |  |
| Piezas plástico-decorativas | ABS  |   | Ice (tapetas)<br>Plata brillo (cromadas)   |
| Cristal                     | Vidrio float de silicato sodocálcico templado térmicamente. Espesor 6 mm     | Cumpliendo Norma EN 12150-2:2005 sobre fragmentación, flexión e impacto | - Transparente*<br>- Transparente + serigrafías*<br>- Mate *<br>Tratamiento "drop free" opcional.<br><br><b>*Ver tabla adjunta junto con referencia mampara.</b> |

### 3- GAMA Y RANGOS DE INSTALACIÓN

En este documento se presenta sólo un extracto de los modelos de la colección **TECHNIC BATIENTE**.

\*Consultar la tarifa vigente **COSMIC SHOWERTIME** para comprobar la viabilidad de otras soluciones.

#### 3.1.- Mamparas de ducha

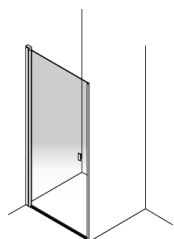

TEDBE1

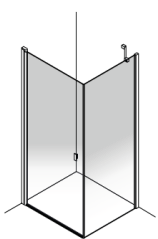

TEDBL1

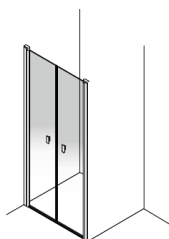

TEDBE2

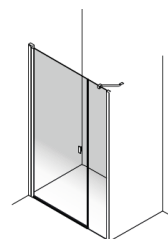

TEDRE2

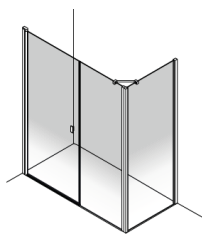

TEDRL2

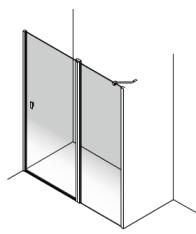

TEDSE2

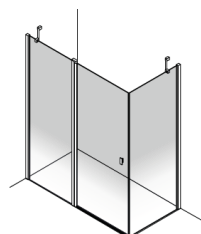

TEDSB2

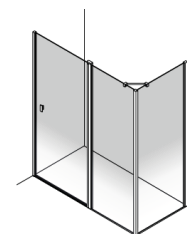

TEDSS2

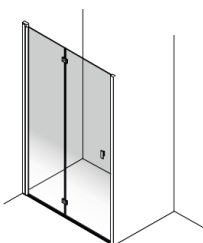

TEDPE2

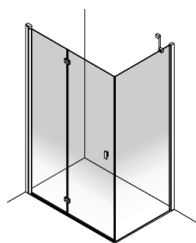

TEDPL2

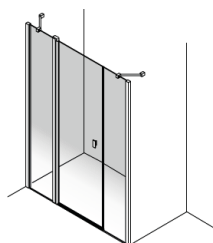

TEDTE3

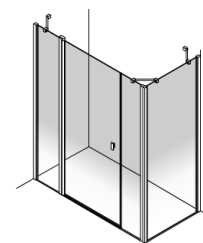

TEDTL3

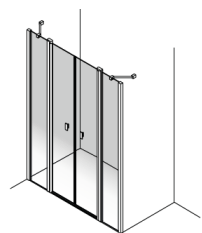

TEDSE4

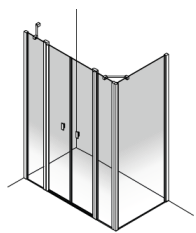

TEDSL4

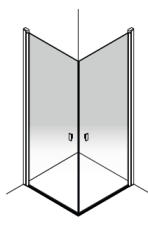

TEABX2

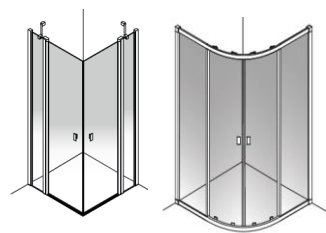

TEASX4



TECS24/34

## DBE1 MAMPARA DE DUCHA: 1 PUERTA BATIENTE ENTRE PAREDES

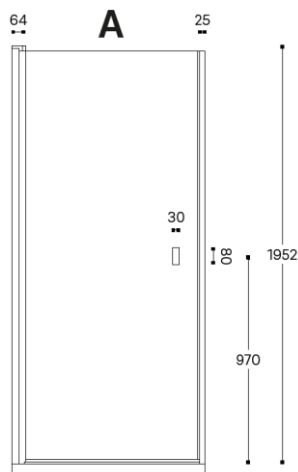
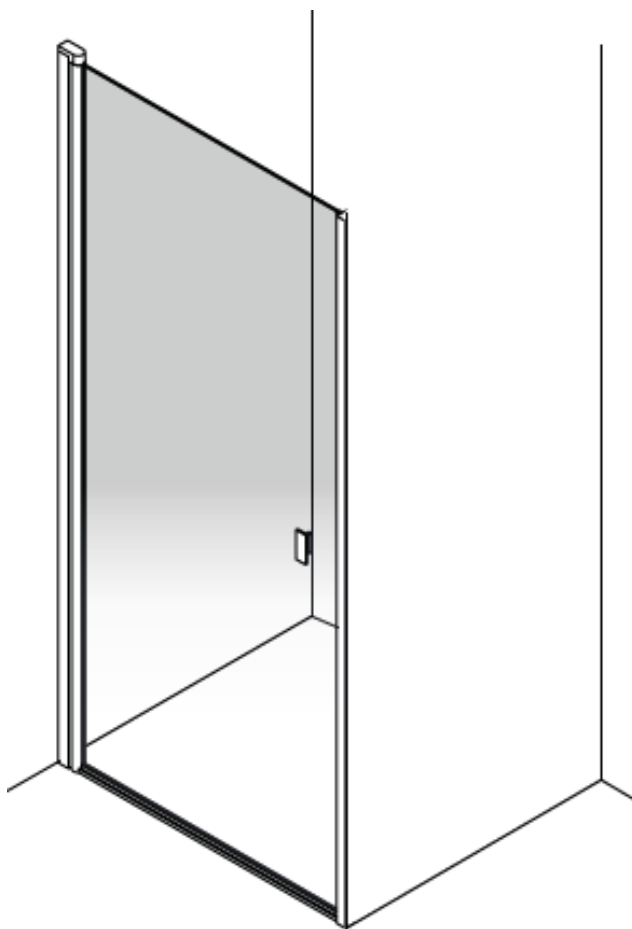

Dimensiones en mm.

### VIDRIO Y DECORADO VIDRO E DECORADO

#### TRANSP.



01

02

03

04



05

06

07

08

#### MATE



19

### ACABADOS METÁLICOS ACABAMENTOS METÁLICOS



1

BLANCO  
BRANCO



2

PLATA BRILLO  
PRATA BRILHO



3

PLATA MATE  
PRATA MATE

## DBL1 MAMPARA DE DUCHA: 1 PUERTA BATIENTE MÁS LATERAL

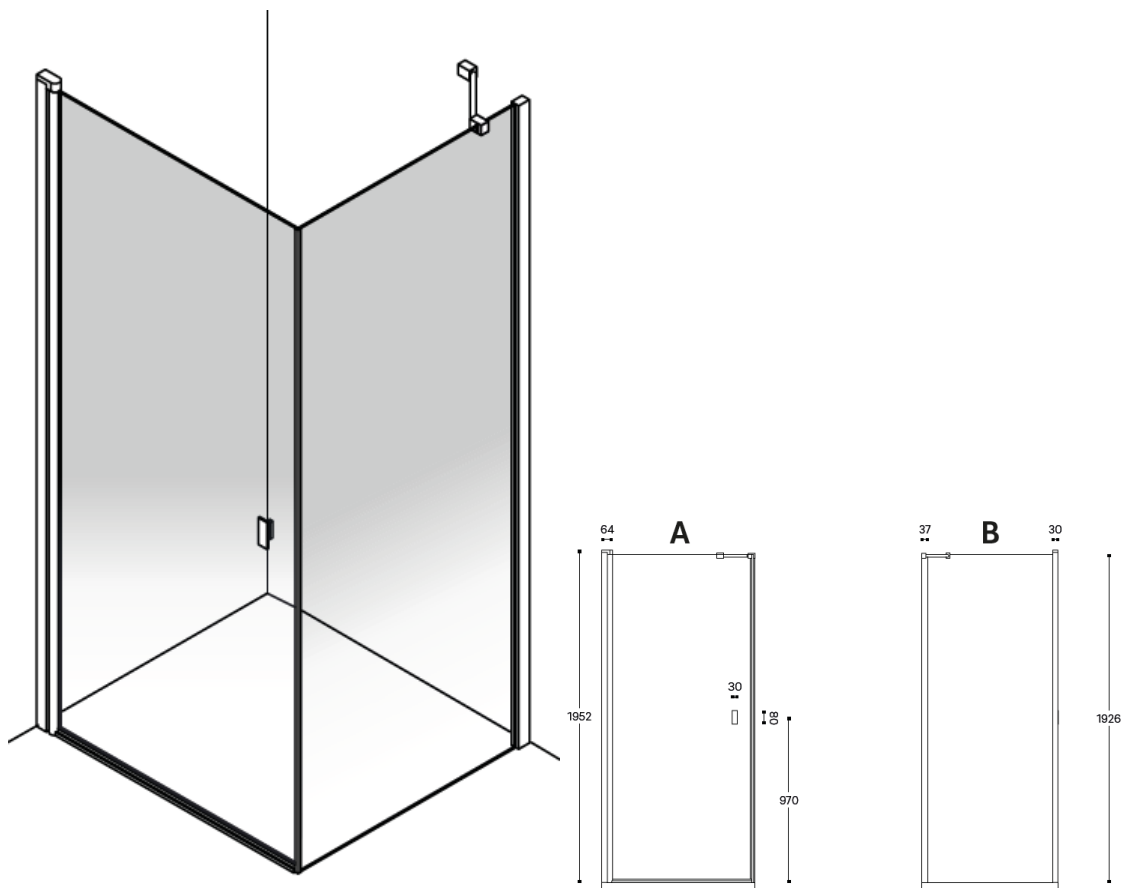

Dimensiones en mm.

### VIDRIO Y DECORADO VIDRO E DECORADO

#### TRANSP.



01

02

03

04

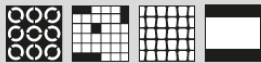

05

06

07

08

#### MATE



19

### ACABADOS METÁLICOS ACABAMENTOS METÁLICOS



BLANCO  
BRANCO

1



PLATA BRILLO  
PRATA BRILHO

2



PLATA MATE  
PRATA MATE

3

## DBE2 MAMPARA DE DUCHA: 2 PUERTAS BATIENTES ENTRE PAREDES

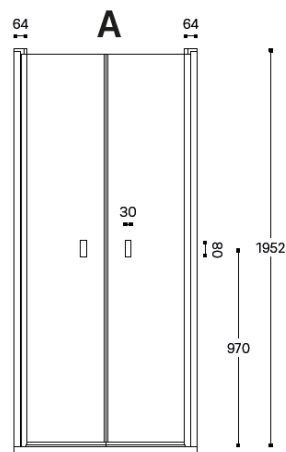
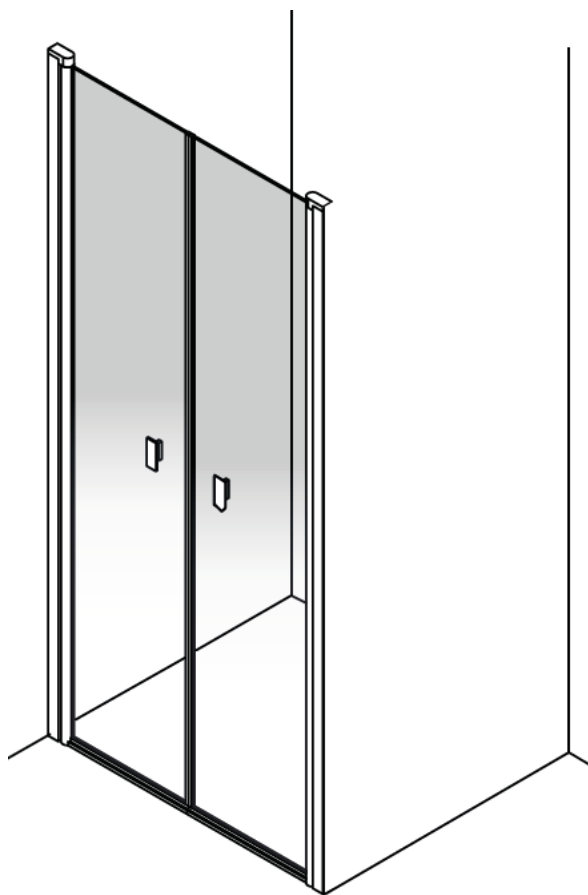

Dimensiones en mm.

REG. MERC. BARCELONA ■ INSCRIPCIÓN 18ª ■ HOJA DUP 3777Z ■ FOLIO 135 ■ TOMO 7322 ■ SEC. GRAL. ■ NIF A-08-219370

### VIDRIO Y DECORADO VIDRO E DECORADO

#### TRANSP.



01 02 03 04

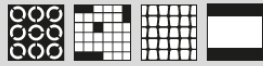

05 06 07 08

#### MATE



19

### ACABADOS METÁLICOS ACABAMENTOS METÁLICOS



1



2



3

## DRE2 MAMPARA DE DUCHA: 1 PUERTA BATIENTE Y 1 FIJO ENTRE PAREDES

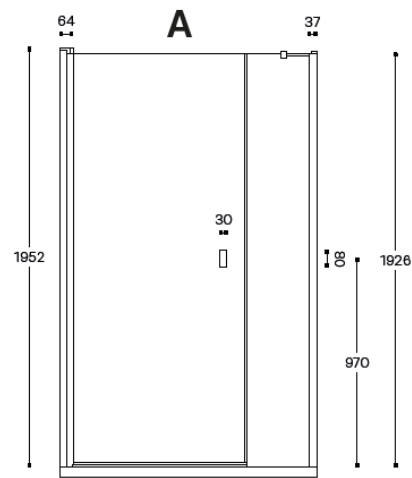
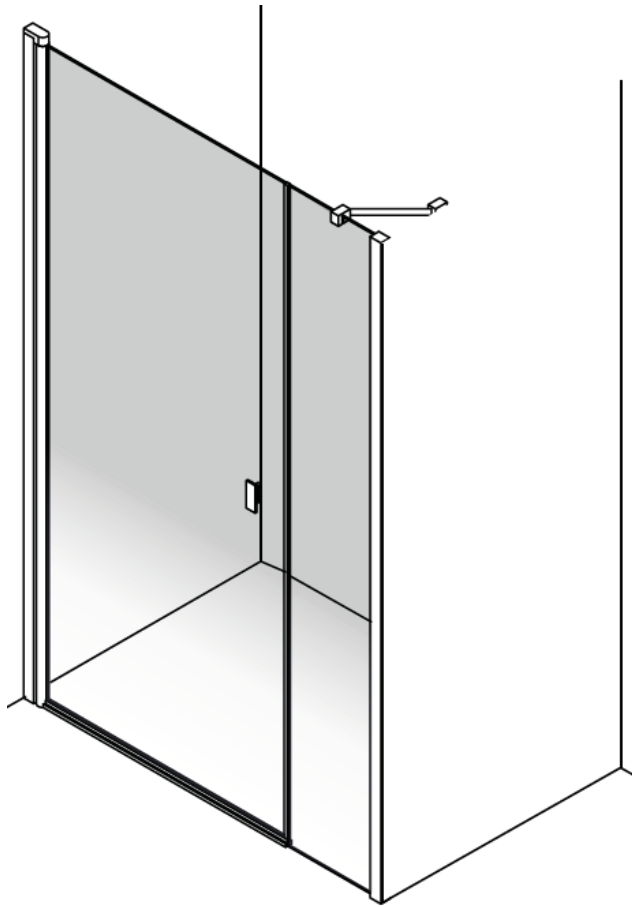

Dimensiones en mm.

### VIDRIO Y DECORADO VIDRO E DECORADO

TRANSP.

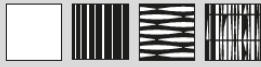

01

02

03

04

MATE



19

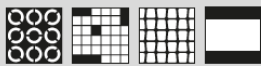

05

06

07

08

### ACABADOS METÁLICOS ACABAMENTOS METÁLICOS



1

BLANCO  
BRANCO



2

PLATA BRILLO  
PRATA BRILHO



3

PLATA MATE  
PRATA MATE

## DRL2 MAMPARA DE DUCHA: 1 PUERTA BATIENTE Y 1 FIJO MÁS LATERAL

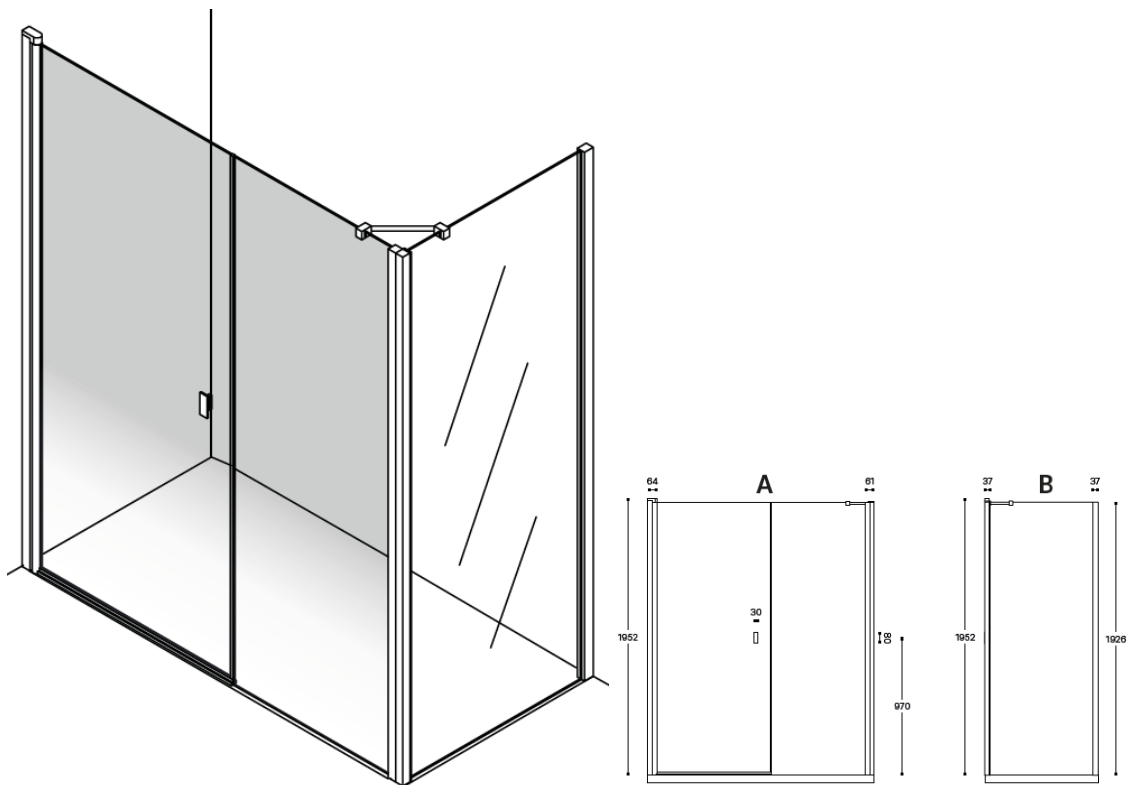

Dimensiones en mm.

### VIDRIO Y DECORADO VIDRO E DECORADO

#### TRANSP.



01

02

03

04

#### MATE



19

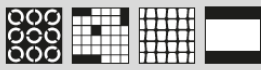

05

06

07

08

### ACABADOS METÁLICOS ACABAMENTOS METÁLICOS



1

BLANCO  
BRANCO



2

PLATA BRILLO  
PRATA BRILHO



3

PLATA MATE  
PRATA MATE



## DSE2 MAMPARA DE DUCHA: 1 PUERTA BATIENTE Y 1 FIJO ENTRE PAREDES

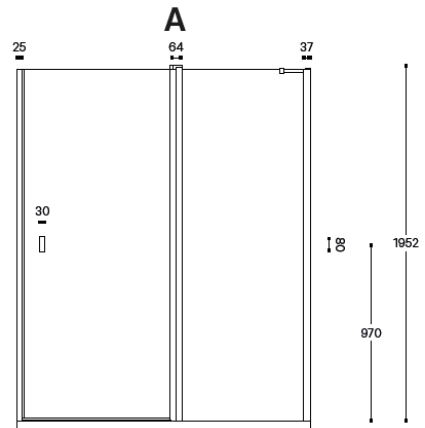
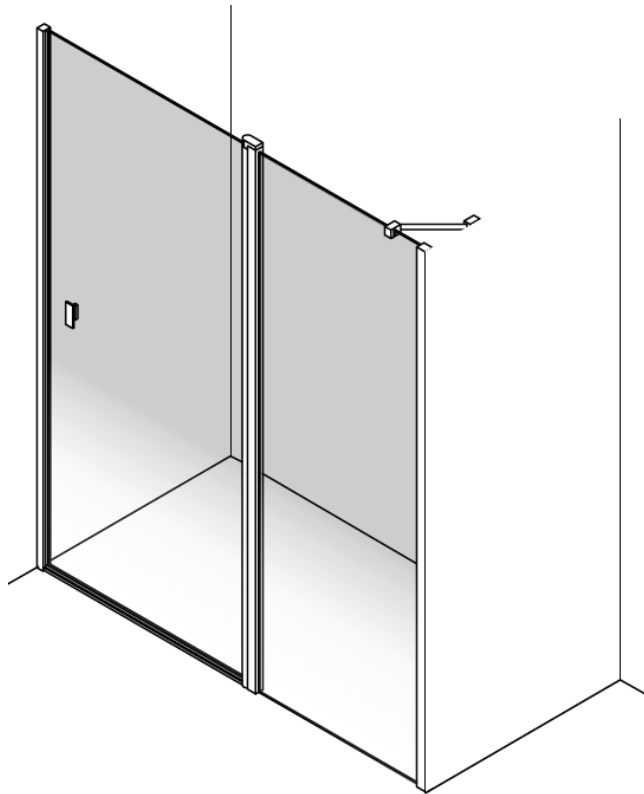

Dimensiones en mm.

### VIDRIO Y DECORADO VIDRO E DECORADO

TRANSP.



01

02

03

04

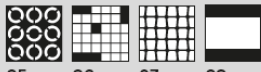

05

06

07

08

MATE



19

### ACABADOS METÁLICOS ACABAMENTOS METÁLICOS



1

BLANCO  
BRANCO



2

PLATA BRILLO  
PRATA BRILHO



3

PLATA MATE  
PRATA MATE

## DSB2 MAMPARA DE DUCHA: 1 PUERTA BATIENTE Y 1 FIJO MÁS LATERAL

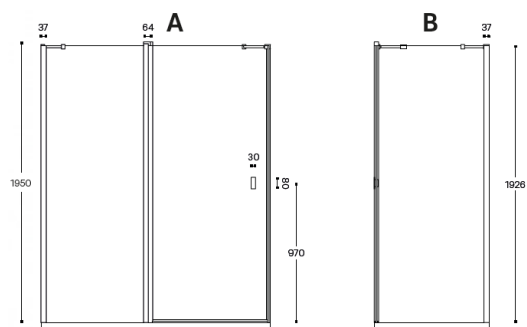
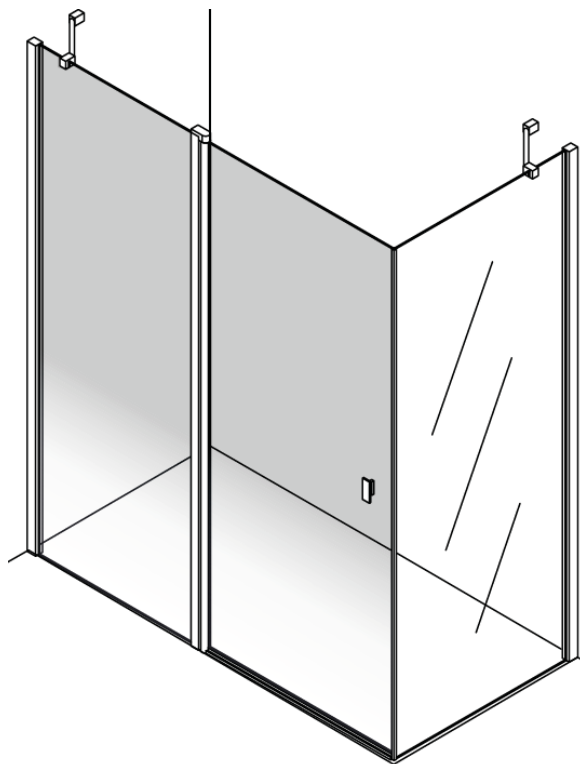

Dimensiones en mm.

### VIDRIO Y DECORADO VIDRO E DECORADO

#### TRANSP.



01

02

03

04

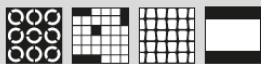

05

06

07

08

#### MATE



19

### ACABADOS METÁLICOS ACABAMENTOS METÁLICOS



1

BLANCO  
BRANCO



2

PLATA BRILLO  
PRATA BRILHO



3

PLATA MATE  
PRATA MATE

## DSS2 MAMPARA DE DUCHA: 1 PUERTA BATIENTE Y 1 FIJO MÁS LATERAL

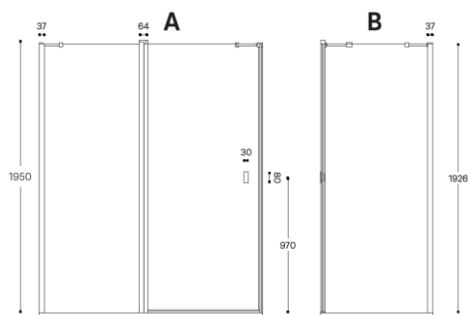
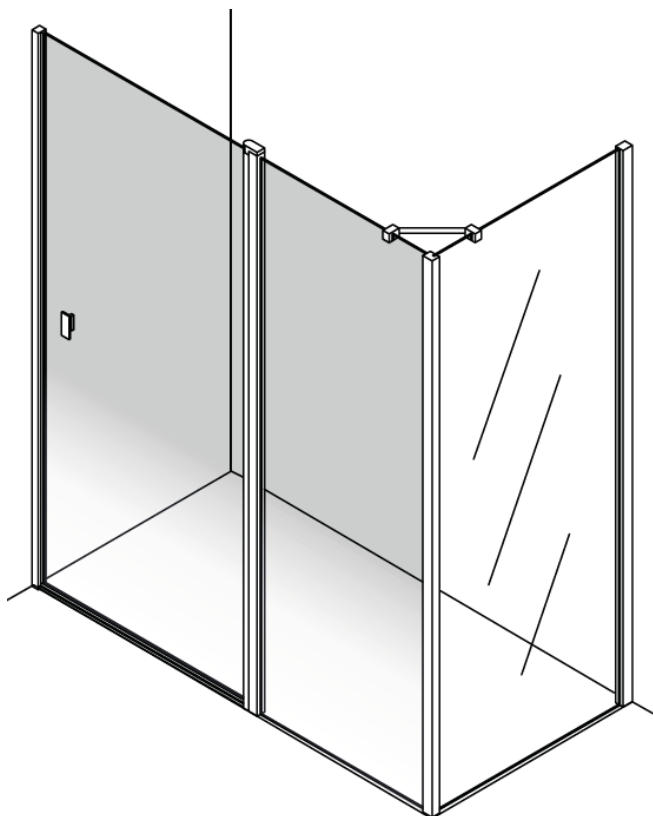

Dimensiones en mm.

### VIDRIO Y DECORADO VIDRO E DECORADO

#### TRANSP.

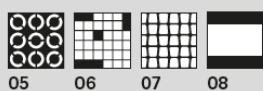

#### MATE



### ACABADOS METÁLICOS ACABAMENTOS METÁLICOS



1

BLANCO  
BRANCO



2

PLATA BRILLO  
PRATA BRILHO



3

PLATA MATE  
PRATA MATE

## DPE2 MAMPARA DE DUCHA: 2 PUERTAS PLEGABLES ENTRE PAREDES

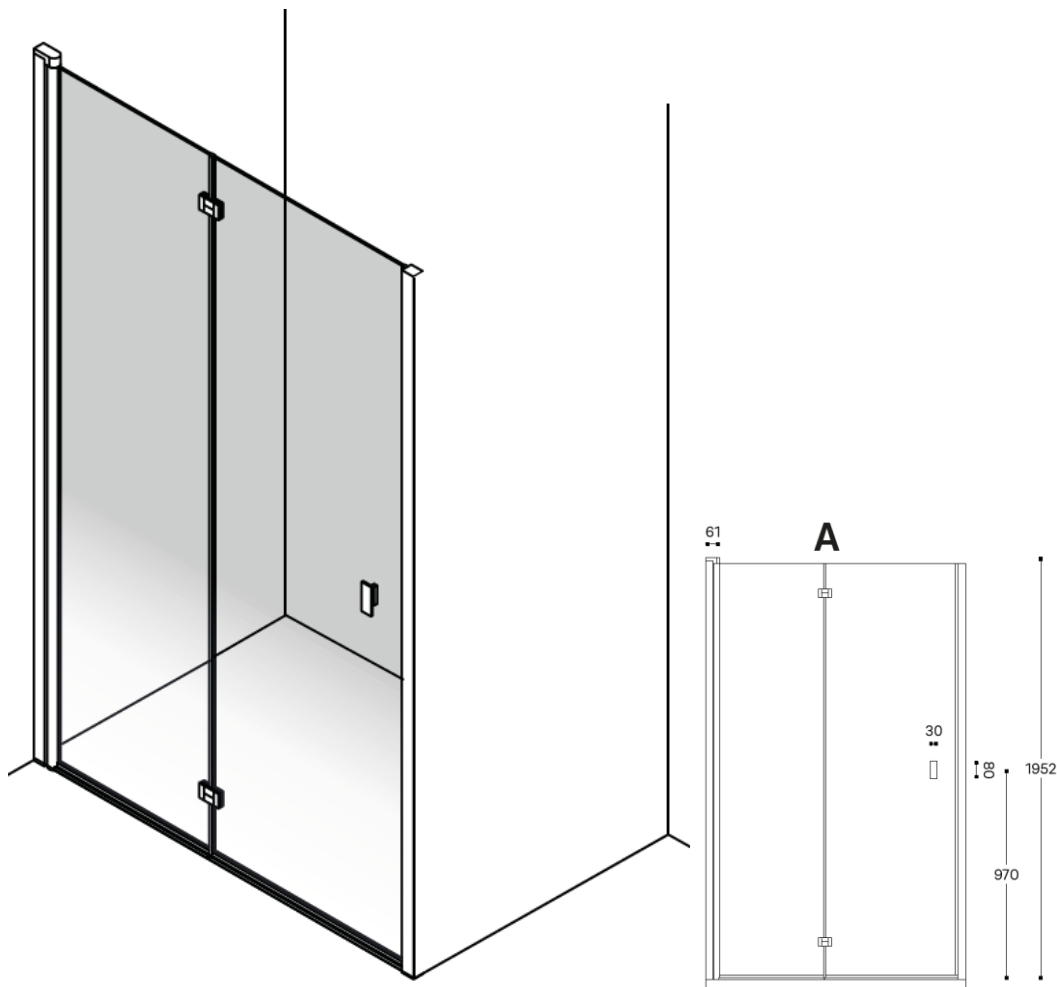

Dimensiones en mm.

### VIDRIO Y DECORADO VIDRO E DECORADO

TRANSP.



01



02



03



04



05



06



07



08

MATE



19

### ACABADOS METÁLICOS ACABAMENTOS METÁLICOS



BLANCO  
BRANCO

1



PLATA BRILLO  
PRATA BRILHO

2



PLATA MATE  
PRATA MATE

3

## DPL2 MAMPARA DE DUCHA: 2 PUERTAS PLEGABLES MÁS LATERAL

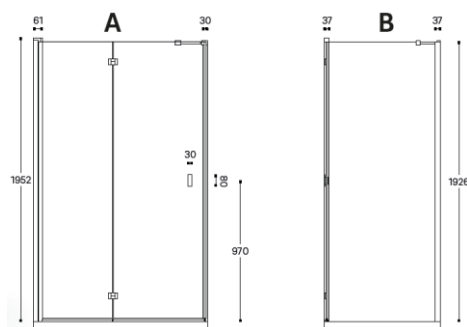
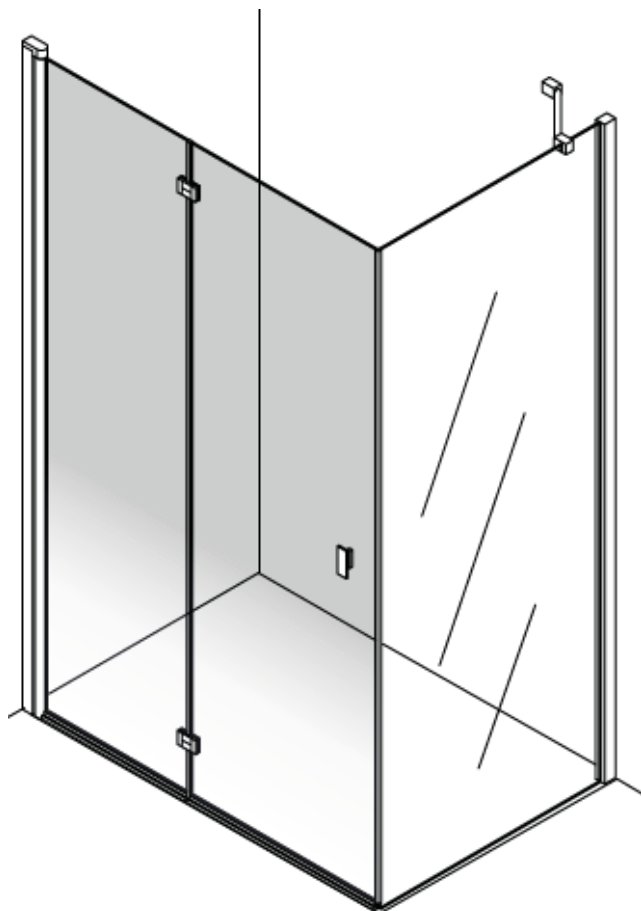

Dimensiones en mm.

### VIDRIO Y DECORADO VIDRO E DECORADO

#### TRANSP.



01

02

03

04



05

06

07

08

#### MATE



19

### ACABADOS METÁLICOS ACABAMENTOS METÁLICOS



1

BLANCO  
BRANCO



2

PLATA BRILLO  
PRATA BRILHO



3

PLATA MATE  
PRATA MATE

## DTE3 MAMPARA DE DUCHA: 1 PUERTA BATIENTE Y 2 FIJOS ENTRE PAREDES

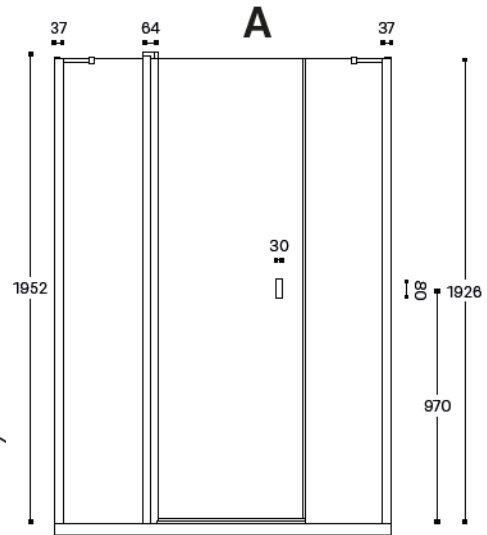
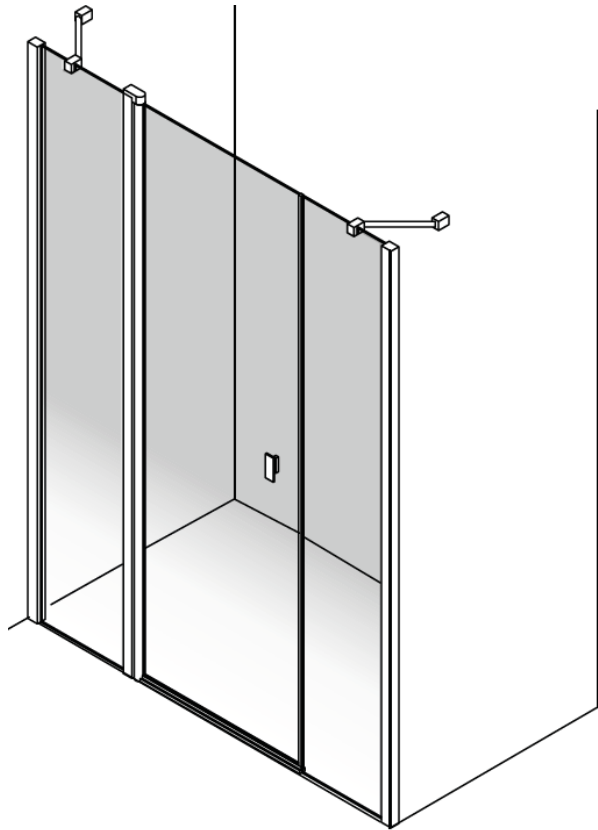

Dimensiones en mm.

### VIDRIO Y DECORADO VIDRO E DECORADO

TRANSP.



01

02

03

04

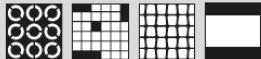

05

06

07

08

MATE



19

### ACABADOS METÁLICOS ACABAMENTOS METÁLICOS



BLANCO  
BRANCO

1



PLATA BRILLO  
PRATA BRILHO

2



PLATA MATE  
PRATA MATE

3

## DTL3 MAMPARA DE DUCHA: 1 PUERTA BATIENTE Y 2 FIJOS MÁS LATERAL

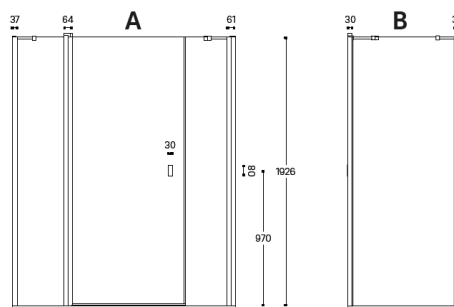
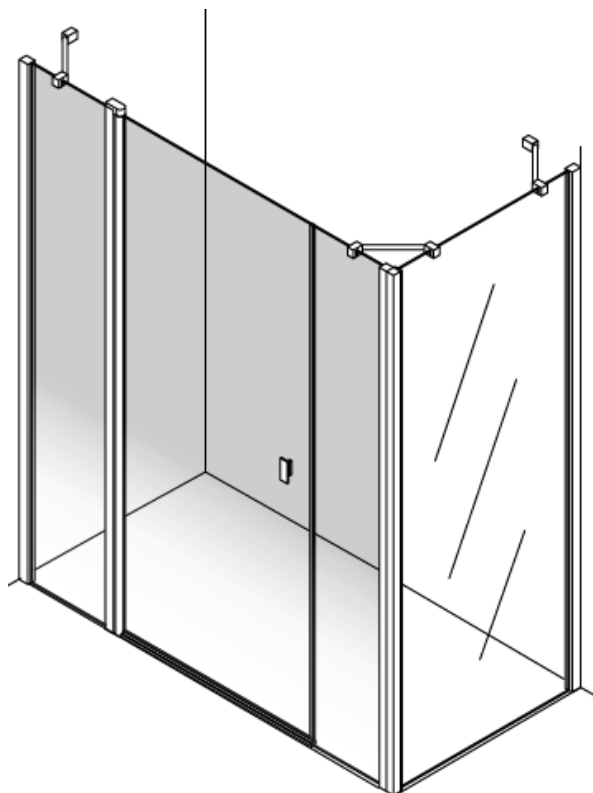

Dimensiones en mm.

### VIDRIO Y DECORADO VIDRO E DECORADO

#### TRANSP.



01

02

03

04



05

06

07

08

#### MATE



19

### ACABADOS METÁLICOS ACABAMENTOS METÁLICOS



1

BLANCO  
BRANCO



2

PLATA BRILLO  
PRATA BRILHO



3

PLATA MATE  
PRATA MATE

## DSE4 MAMPARA DE DUCHA: 1 PUERTA BATIENTE Y 2 FIJOS MÁS LATERAL

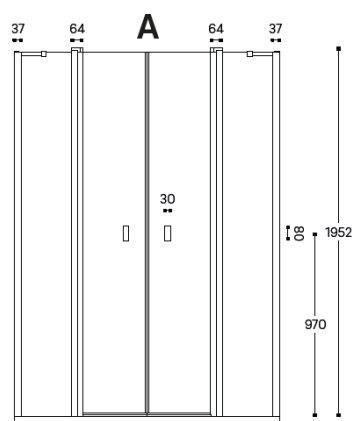
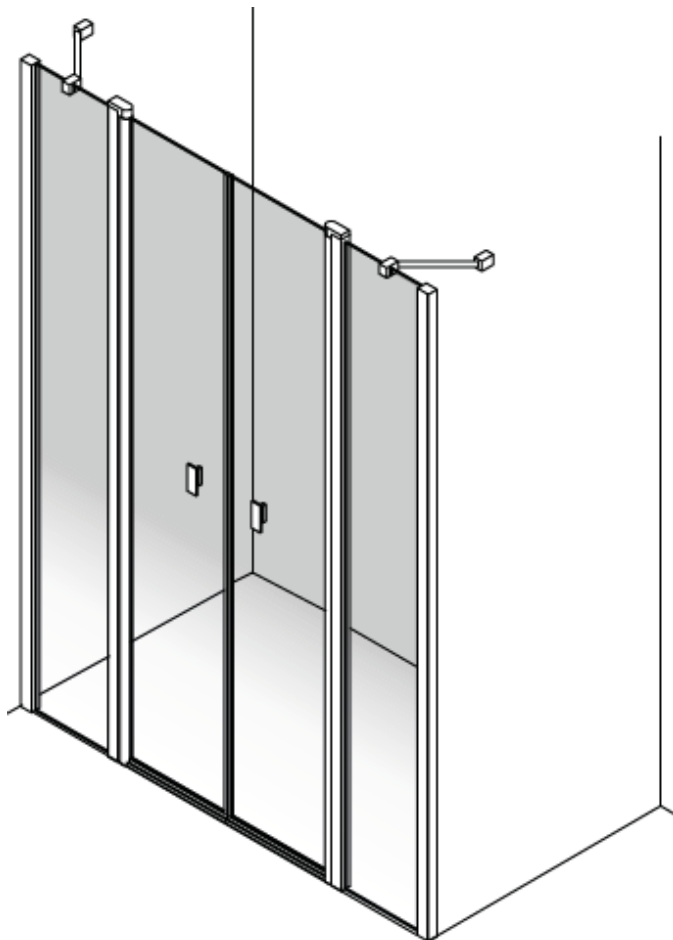

Dimensiones en mm.

### VIDRIO Y DECORADO VIDRO E DECORADO

#### TRANSP.



01

02

03

04



05

06

07

08

#### MATE



19

### ACABADOS METÁLICOS ACABAMENTOS METÁLICOS



1

BLANCO  
BRANCO



2

PLATA BRILLO  
PRATA BRILHO



3

PLATA MATE  
PRATA MATE



## DSL4 FRONTAL DE DUCHA: 2 PUERTAS BATIENTES Y 2 FIJOS MÁS LATERAL

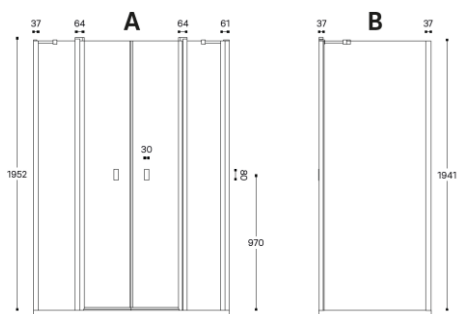
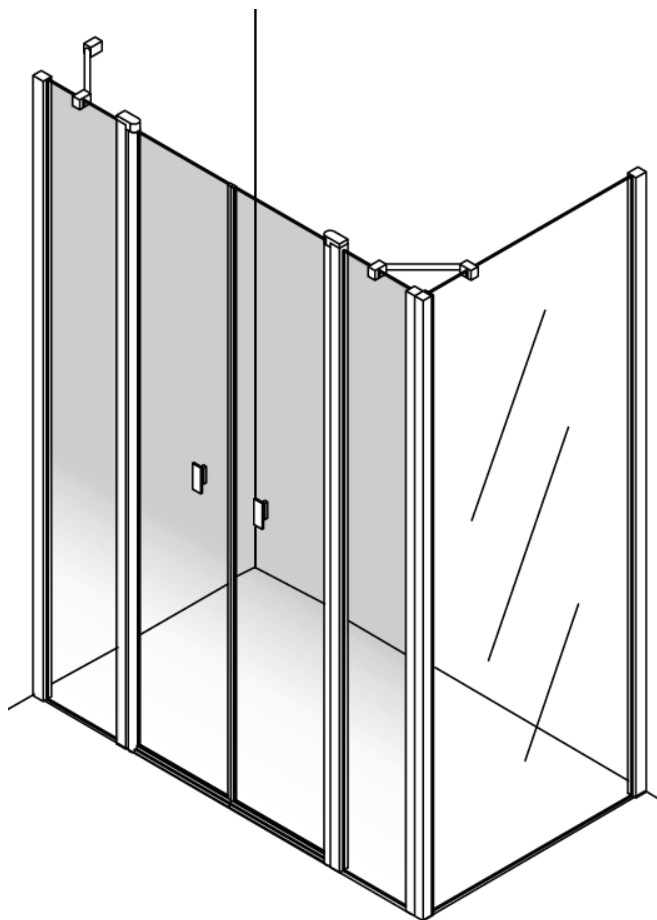

Dimensiones en mm.

### VIDRIO Y DECORADO VIDRO E DECORADO

TRANSP.



01

02

03

04

MATE



19

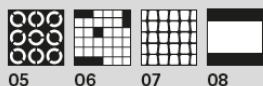

05

06

07

08

### ACABADOS METÁLICOS ACABAMENTOS METÁLICOS



1

BLANCO  
BRANCO



2

PLATA BRILLO  
PRATA BRILHO



3

PLATA MATE  
PRATA MATE

## ABX2 MAMPARA ANGULAR: 2 PUERTAS BATIENTES

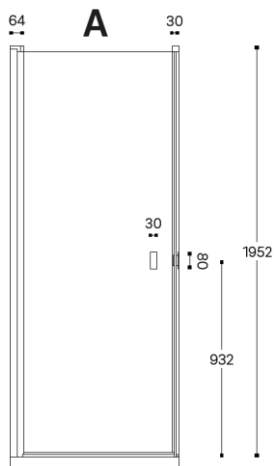
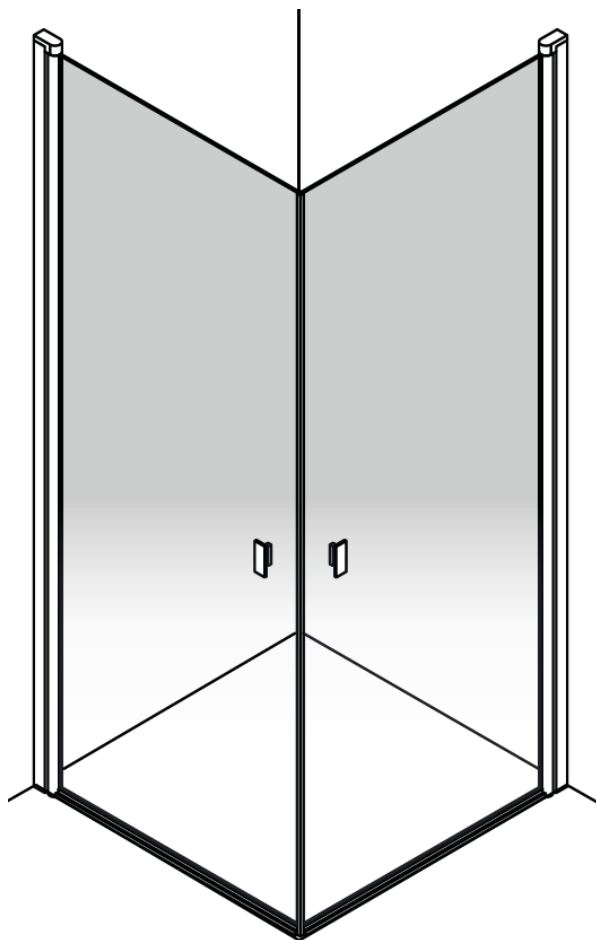

Dimensiones en mm.

### VIDRIO Y DECORADO VIDRO E DECORADO

#### TRANSP.

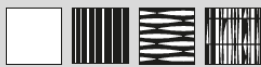

01

02

03

04

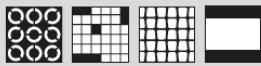

05

06

07

08

#### MATE



19

### ACABADOS METÁLICOS ACABAMENTOS METÁLICOS



1



2



3

## ASX4 MAMPARA ANGULAR: 2 PUERTAS BATIENTES Y 2 FIJOS

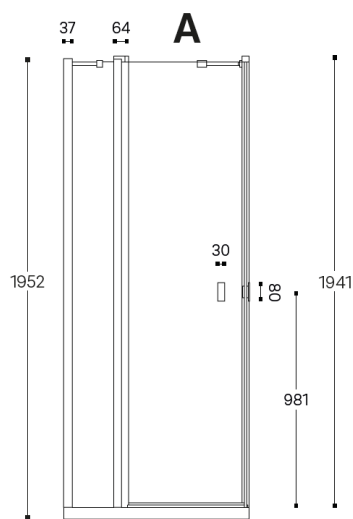
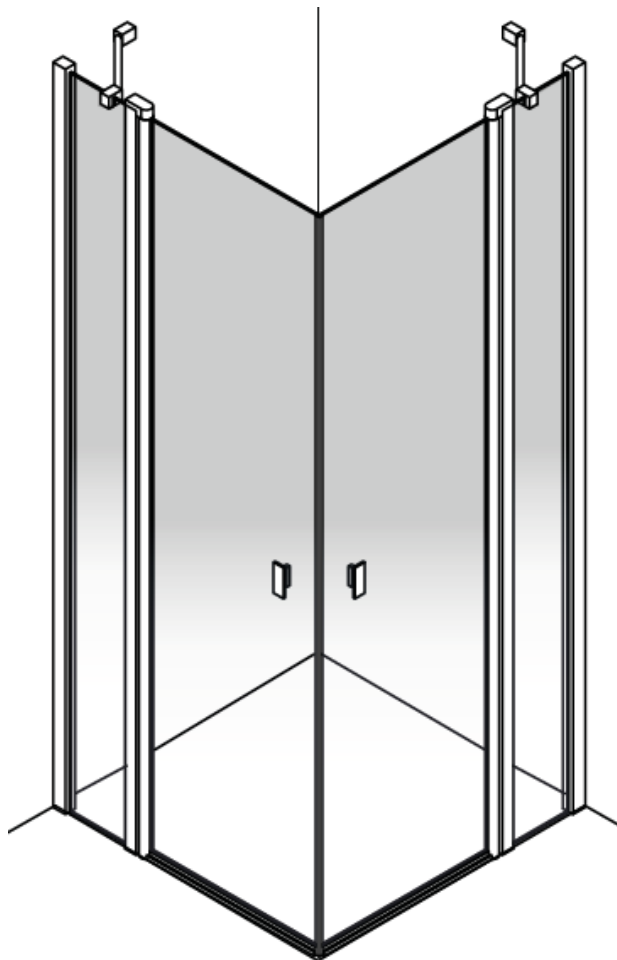

Dimensiones en mm.

### VIDRIO Y DECORADO VIDRO E DECORADO

#### TRANSP.

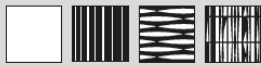

01

02

03

04

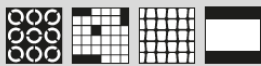

05

06

07

08

#### MATE



19

### ACABADOS METÁLICOS ACABAMENTOS METÁLICOS



BLANCO  
BRANCO

1



PLATA BRILLO  
PRATA BRILHO

2



PLATA MATE  
PRATA MATE

3

## CS24-CS34 MAMPARA CUARTOANGULAR: 2 PUERTAS BATIENTES Y 2 FIJOS

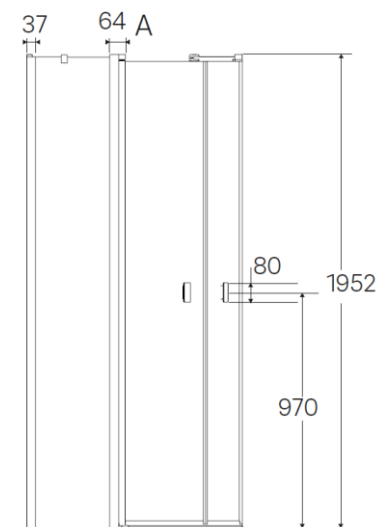
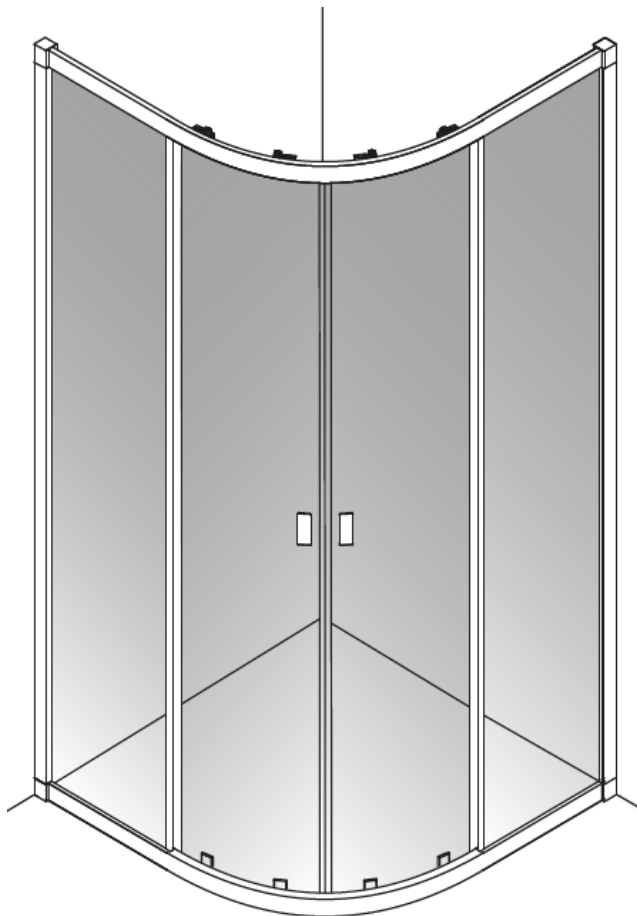

Dimensiones en mm.

### VIDRIO Y DECORADO VIDRO E DECORADO

#### TRANSP.

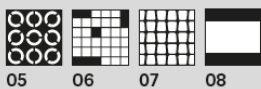

#### MATE



### ACABADOS METÁLICOS ACABAMENTOS METÁLICOS



1



2



3